

4-SP-P Jaws with adjustable length (pair)



DESCRIPTION

The pair of two height-adjustable puller jaws is suitable for 2-jaw pullers. The robust puller jaws guarantee a particularly safe removal of bearings, gears, and discs.

APPLICATION AREA

Accessories for particularly safe removal of bearings, gears, and discs.

BENEFIT

- Through the freely movable jaws gliding on the crossbar, even eccentric components can be removed.

MASTER DATA

GTIN [EAN]	4021176004636
Country of origin	DE
Case material	Tool steel
Series	SP-P
Net weight [kg]	8,965 kg
Package contents	1 few
Packaging Act	PAP 21
Global sales capability given	Yes (REACH, RoHS, POP, PROP65, TSCA)

DETAIL IMAGE



Jaws with adjustable length (pair)

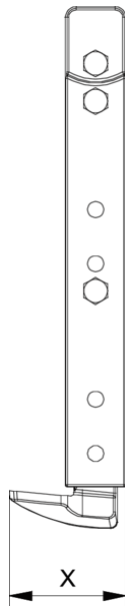

Abbreviation	Attribut	Wert
A	Clamping depth outside pull-off [mm]	500 mm
K	Hook root thickness at the tip (claw thickness K) [mm]	7 mm
J	Hook base width (claw width J) [mm]	45 mm
O	Hook base depth usable (claw depth usable O) [mm]	50 mm
H	Total hook root depth (total claw depth H) [mm]	85 mm
L	Total claw thickness (L+1mm) (claw distance to base surface) [mm]	25 mm
Z	Total length [mm]	565 mm

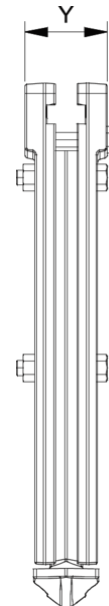

Abbreviation	Attribut	Wert
A	Clamping depth outside pull-off [mm]	500 mm
K	Hook root thickness at the tip (claw thickness K) [mm]	7 mm
J	Hook base width (claw width J) [mm]	45 mm
O	Hook base depth usable (claw depth usable O) [mm]	50 mm
H	Total hook root depth (total claw depth H) [mm]	85 mm
L	Total claw thickness (L+1mm) (claw distance to base surface) [mm]	25 mm
Z	Total length [mm]	565 mm

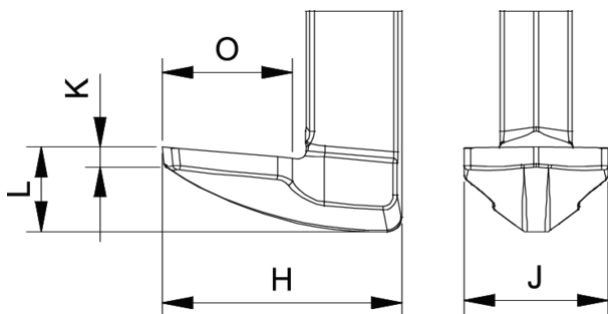

Abbreviation	Attribut	Wert
A	Clamping depth outside pull-off [mm]	500 mm
K	Hook root thickness at the tip (claw thickness K) [mm]	7 mm
J	Hook base width (claw width J) [mm]	45 mm
O	Hook base depth usable (claw depth usable O) [mm]	50 mm
H	Total hook root depth (total claw depth H) [mm]	85 mm
L	Total claw thickness (L+1mm) (claw distance to base surface) [mm]	25 mm
Z	Total length [mm]	565 mm

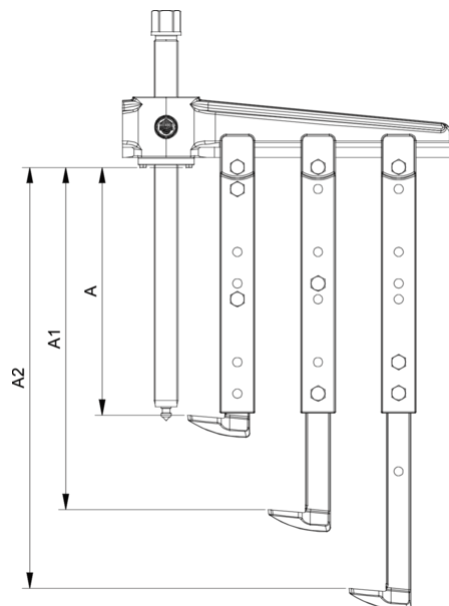

Abbreviation	Attribut	Wert
A	Clamping depth outside pull-off [mm]	500 mm
K	Hook root thickness at the tip (claw thickness K) [mm]	7 mm

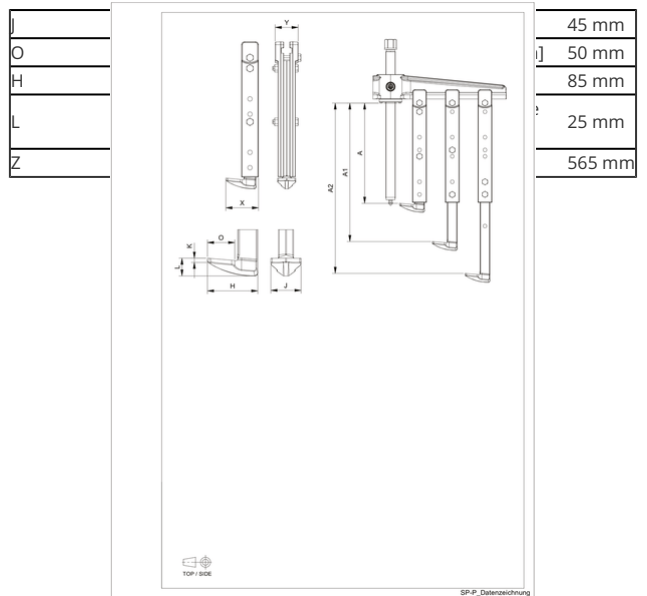

Abbreviation	Attribut	Wert
A	Clamping depth outside pull-off [mm]	500 mm
K	Hook root thickness at the tip (claw thickness K) [mm]	7 mm
J	Hook base width (claw width J) [mm]	45 mm
O	Hook base depth usable (claw depth usable O) [mm]	50 mm
H	Total hook root depth (total claw depth H) [mm]	85 mm
L	Total claw thickness (L+1mm) (claw distance to base surface) [mm]	25 mm
Z	Total length [mm]	565 mm