

1-95-S Extremely narrow, quick adjustment jaws (set, reach 100 mm)



DESCRIPTION

The set of three extremely narrow, quick-adjustable jaws is suitable for 3-jaw universal pullers. The trapezoidal contact surface of the claw ensures that even very tight and poorly accessible gaps can be reached.

APPLICATION AREA

As accessories for very narrow and hard-to-reach gaps.

BENEFIT

- The movable puller jaws gliding on the crossbar allow for the extraction of eccentric components.
- Thanks to the knurl, a tool-free, quick release or movement of the jaws is made possible.

MASTER DATA

GTIN [EAN]	4021176321634
Country of origin	DE
Case material	Tool steel
Series	5-S
Net weight [kg]	0,81 kg
Package contents	1 set
Packaging Act	PAP 21
Global sales capability given	Yes (REACH, RoHS, POP, PROP65, TSCA)

DETAIL IMAGE

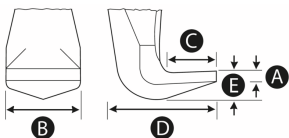

Extremely narrow, quick adjustment jaws (set, reach 100 mm)

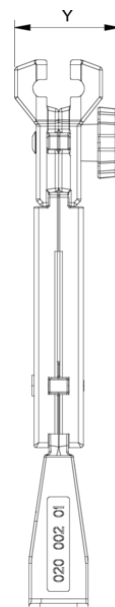

Abbreviation	Attribut	Wert
A	Clamping depth outside pull-off [mm]	100 mm
K	Hook root thickness at the tip (claw thickness K) [mm]	3 mm
J	Hook base width (claw width J) [mm]	24 mm
O	Hook base depth usable (claw depth usable O) [mm]	7 mm
H	Total hook root depth (total claw depth H) [mm]	12 mm
L	Total claw thickness (L+1mm) (claw distance to base surface) [mm]	3 mm
Z	Total length [mm]	127 mm

Abbreviation	Attribut	Wert
A	Clamping depth outside pull-off [mm]	100 mm
K	Hook root thickness at the tip (claw thickness K) [mm]	3 mm
J	Hook base width (claw width J) [mm]	24 mm
O	Hook base depth usable (claw depth usable O) [mm]	7 mm
H	Total hook root depth (total claw depth H) [mm]	12 mm
L	Total claw thickness (L+1mm) (claw distance to base surface) [mm]	3 mm
Z	Total length [mm]	127 mm

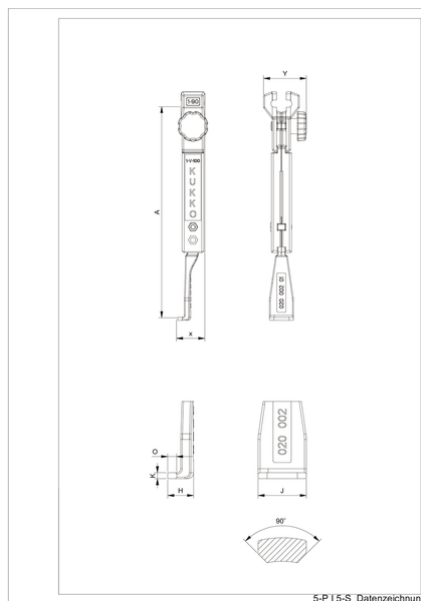
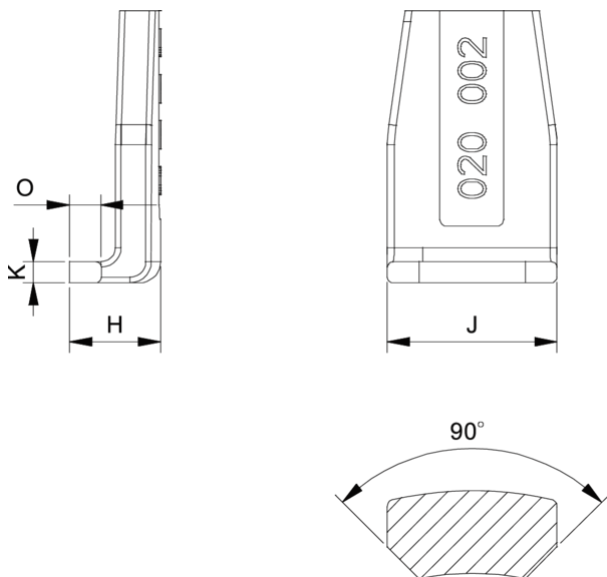

Abbreviation	Attribut	Wert
A	Clamping depth outside pull-off [mm]	100 mm
K	Hook root thickness at the tip (claw thickness K) [mm]	3 mm
J	Hook base width (claw width J) [mm]	24 mm

Abbreviation	Attribut	Wert
A	Clamping depth outside pull-off [mm]	100 mm
K	Hook root thickness at the tip (claw thickness K) [mm]	3 mm

O	Hook base depth usable (claw depth usable O) [mm]	7 mm
H	Total hook root depth (total claw depth H) [mm]	12 mm
L	Total claw thickness (L+1mm) (claw distance to base surface) [mm]	3 mm
Z	Total length [mm]	127 mm

J	Hook base width (claw width J) [mm]	24 mm
O	Hook base depth usable (claw depth usable O) [mm]	7 mm
H	Total hook root depth (total claw depth H) [mm]	12 mm
L	Total claw thickness (L+1mm) (claw distance to base surface) [mm]	3 mm
Z	Total length [mm]	127 mm