

3-303-S Narrow, quick adjustment standard jaws (set, reach 300 mm)



DESCRIPTION

The set of three narrow, quickly adjustable jaws is suitable for 3-jaw universal pullers. The narrow jaws ensure that even tight and hard-to-reach spaces can be accessed.

APPLICATION AREA

Suitable for 3-arm universal puller

BENEFIT

- The freely movable pulling jaws, which glide on the crossbar, can also be used to remove eccentric components.
- Thanks to the knurling, a tool-free, quick release or movement of the trigger jaws is possible.

MASTER DATA

GTIN [EAN]	4021176973994
Country of origin	DE
Case material	Tool steel
Series	3-S
Net weight [kg]	4,265 kg
Package contents	1 set
Packaging Act	PAP 21
Global sales capability given	Yes (REACH, RoHS, POP, PROP65, TSCA)

DETAIL IMAGE

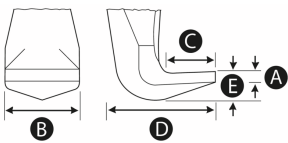

Narrow, quick adjustment standard jaws (set, reach 300 mm)

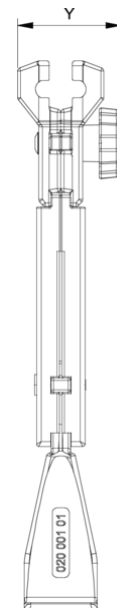
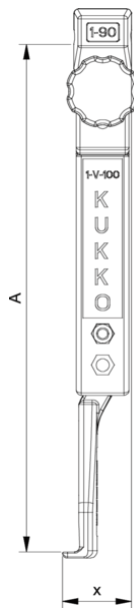

Abbreviation	Attribut	Wert
A	Clamping depth outside pull-off [mm]	300 mm
K	Hook root thickness at the tip (claw thickness K) [mm]	6,5 mm
J	Hook base width (claw width J) [mm]	35 mm
O	Hook base depth usable (claw depth usable O) [mm]	17 mm
H	Total hook root depth (total claw depth H) [mm]	52 mm
L	Total claw thickness (L+1mm) (claw distance to base surface) [mm]	6,5 mm
Z	Total length [mm]	340 mm

Abbreviation	Attribut	Wert
A	Clamping depth outside pull-off [mm]	300 mm
K	Hook root thickness at the tip (claw thickness K) [mm]	6,5 mm
J	Hook base width (claw width J) [mm]	35 mm
O	Hook base depth usable (claw depth usable O) [mm]	17 mm
H	Total hook root depth (total claw depth H) [mm]	52 mm
L	Total claw thickness (L+1mm) (claw distance to base surface) [mm]	6,5 mm
Z	Total length [mm]	340 mm

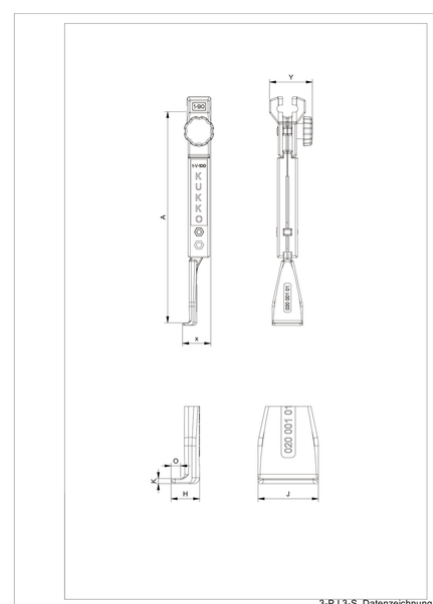
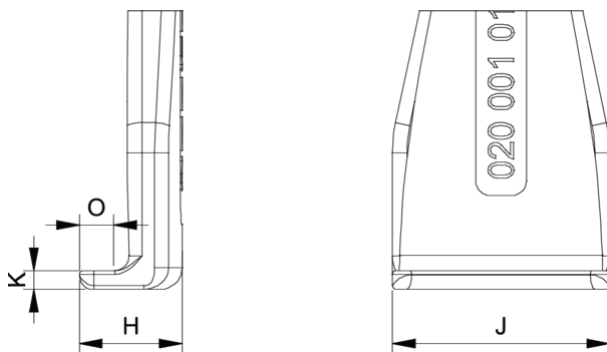

Abbreviation	Attribut	Wert
A	Clamping depth outside pull-off [mm]	300 mm
K	Hook root thickness at the tip (claw thickness K) [mm]	6,5 mm
J	Hook base width (claw width J) [mm]	35 mm
O	Hook base depth usable (claw depth usable O) [mm]	17 mm
H	Total hook root depth (total claw depth H) [mm]	52 mm
L	Total claw thickness (L+1mm) (claw distance to base surface) [mm]	6,5 mm
Z	Total length [mm]	340 mm

Abbreviation	Attribut	Wert
A	Clamping depth outside pull-off [mm]	300 mm
K	Hook root thickness at the tip (claw thickness K) [mm]	6,5 mm

J	Hook base width (claw width J) [mm]	35 mm
O	Hook base depth usable (claw depth usable O) [mm]	17 mm
H	Total hook root depth (total claw depth H) [mm]	52 mm
L	Total claw thickness (L+1mm) (claw distance to base surface) [mm]	6,5 mm
Z	Total length [mm]	340 mm