

2-152-S Quick adjustable standard jaws (set, reach 150 mm)



DESCRIPTION

The set of three quickly adjustable standard jaws is suitable for 3-jaw universal pullers. The robust jaws guarantee particularly safe and user-friendly removal of bearings, gears, and discs.

APPLICATION AREA

Suitable for 3-arm universal puller

BENEFIT

- Through the freely movable, sliding jaws on the crossbar, even eccentric components can be pulled off.
- Thanks to the knurling, it enables tool-free, quick loosening or moving of the jaws.

MASTER DATA

GTIN [EAN]	4021176973772
Country of origin	DE
Case material	Tool steel
Series	2-S
Net weight [kg]	2,75 kg
Package contents	1 set
Packaging Act	PAP 21
Global sales capability given	Yes (REACH, RoHS, POP, PROP65, TSCA)

DETAIL IMAGE



Quick adjustable standard jaws (set, reach 150 mm)

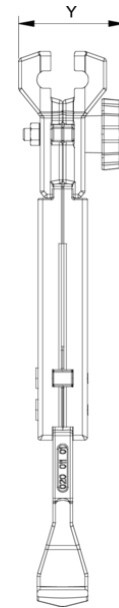
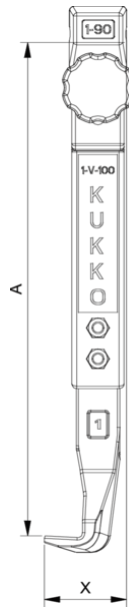

Abbreviation	Attribut	Wert
A	Clamping depth outside pull-off [mm]	150 mm
K	Hook root thickness at the tip (claw thickness K) [mm]	4 mm
J	Hook base width (claw width J) [mm]	24 mm
O	Hook base depth usable (claw depth usable O) [mm]	18 mm
H	Total hook root depth (total claw depth H) [mm]	40 mm
L	Total claw thickness (L+1mm) (claw distance to base surface) [mm]	9 mm
Z	Total length [mm]	193 mm

Abbreviation	Attribut	Wert
A	Clamping depth outside pull-off [mm]	150 mm
K	Hook root thickness at the tip (claw thickness K) [mm]	4 mm
J	Hook base width (claw width J) [mm]	24 mm
O	Hook base depth usable (claw depth usable O) [mm]	18 mm
H	Total hook root depth (total claw depth H) [mm]	40 mm
L	Total claw thickness (L+1mm) (claw distance to base surface) [mm]	9 mm
Z	Total length [mm]	193 mm

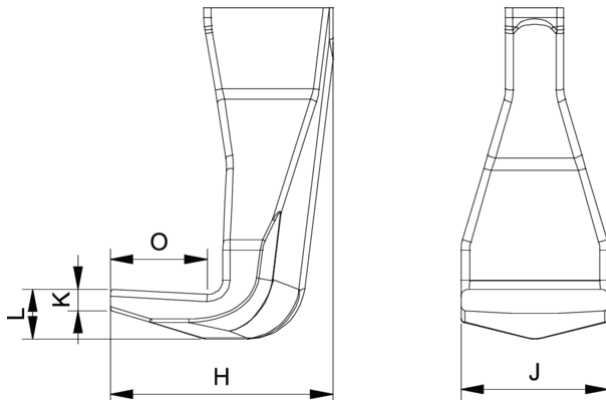

Abbreviation	Attribut	Wert
A	Clamping depth outside pull-off [mm]	150 mm
K	Hook root thickness at the tip (claw thickness K) [mm]	4 mm
J	Hook base width (claw width J) [mm]	24 mm
O	Hook base depth usable (claw depth usable O) [mm]	18 mm
H	Total hook root depth (total claw depth H) [mm]	40 mm
L	Total claw thickness (L+1mm) (claw distance to base surface) [mm]	9 mm
Z	Total length [mm]	193 mm

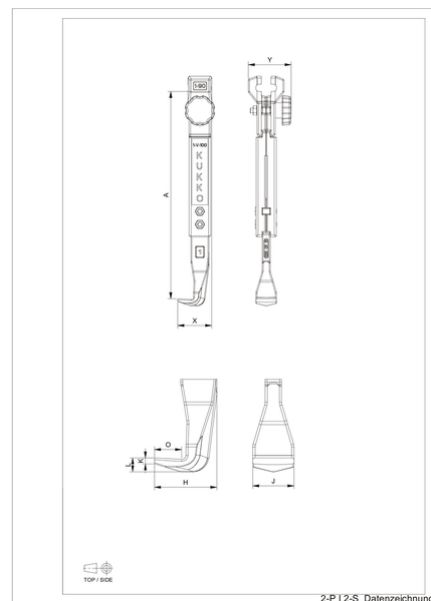

Abbreviation	Attribut	Wert
A	Clamping depth outside pull-off [mm]	150 mm
K	Hook root thickness at the tip (claw thickness K) [mm]	4 mm

J	Hook base width (claw width J) [mm]	24 mm
O	Hook base depth usable (claw depth usable O) [mm]	18 mm
H	Total hook root depth (total claw depth H) [mm]	40 mm
L	Total claw thickness (L+1mm) (claw distance to base surface) [mm]	9 mm
Z	Total length [mm]	193 mm