

2-302-P Quick-adjust standard jaws (pair, reach 300 mm)



DESCRIPTION

The pair of two quick-adjustable standard jaws is suitable for 2-jaw universal pullers. The robust jaws guarantee particularly safe and user-friendly removal of bearings, gears, and disks.

APPLICATION AREA

As accessories for particularly safe and user-friendly removal of bearings, gears, and discs.

BENEFIT

- The movable puller jaws that glide on the crossbar allow for the removal of eccentric components as well.
- Through the knurl, a tool-free, quick solution or movement of the jaws is made possible.

MASTER DATA

GTIN [EAN]	4021176973819
Country of origin	DE
Case material	Tool steel
Series	2-P
Net weight [kg]	2,59 kg
Package contents	1 few
Packaging Act	PAP 21
Global sales capability given	Yes (REACH, RoHS, POP, PROP65, TSCA)

DETAIL IMAGE

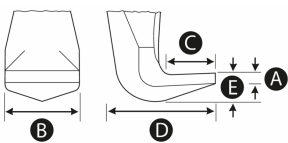

Quick-adjust standard jaws (pair, reach 300 mm)

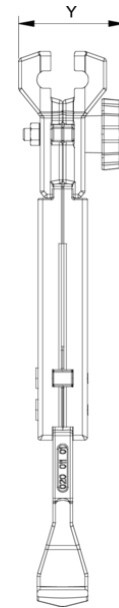
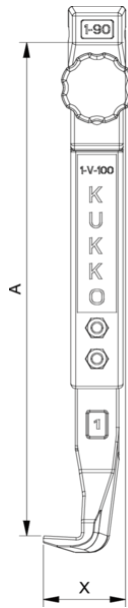

Abbreviation	Attribut	Wert
A	Clamping depth outside pull-off [mm]	300 mm
K	Hook root thickness at the tip (claw thickness K) [mm]	4 mm
J	Hook base width (claw width J) [mm]	24 mm
O	Hook base depth usable (claw depth usable O) [mm]	18 mm
H	Total hook root depth (total claw depth H) [mm]	40 mm
L	Total claw thickness (L+1mm) (claw distance to base surface) [mm]	9 mm
Z	Total length [mm]	343 mm

Abbreviation	Attribut	Wert
A	Clamping depth outside pull-off [mm]	300 mm
K	Hook root thickness at the tip (claw thickness K) [mm]	4 mm
J	Hook base width (claw width J) [mm]	24 mm
O	Hook base depth usable (claw depth usable O) [mm]	18 mm
H	Total hook root depth (total claw depth H) [mm]	40 mm
L	Total claw thickness (L+1mm) (claw distance to base surface) [mm]	9 mm
Z	Total length [mm]	343 mm

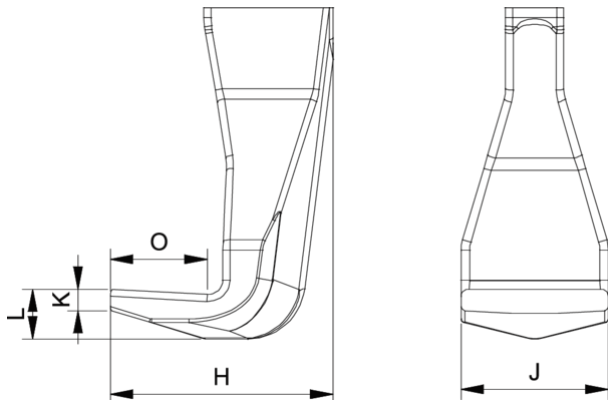

Abbreviation	Attribut	Wert
A	Clamping depth outside pull-off [mm]	300 mm
K	Hook root thickness at the tip (claw thickness K) [mm]	4 mm
J	Hook base width (claw width J) [mm]	24 mm
O	Hook base depth usable (claw depth usable O) [mm]	18 mm
H	Total hook root depth (total claw depth H) [mm]	40 mm
L	Total claw thickness (L+1mm) (claw distance to base surface) [mm]	9 mm
Z	Total length [mm]	343 mm

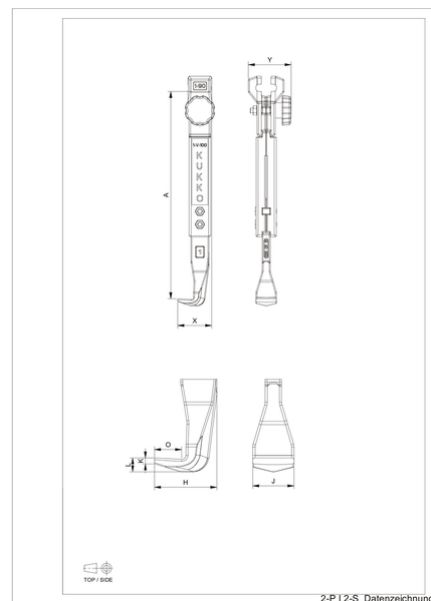

Abbreviation	Attribut	Wert
A	Clamping depth outside pull-off [mm]	300 mm
K	Hook root thickness at the tip (claw thickness K) [mm]	4 mm

J	Hook base width (claw width J) [mm]	24 mm
O	Hook base depth usable (claw depth usable O) [mm]	18 mm
H	Total hook root depth (total claw depth H) [mm]	40 mm
L	Total claw thickness (L+1mm) (claw distance to base surface) [mm]	9 mm
Z	Total length [mm]	343 mm