

# 1-194-S Extremely narrow jaws (set, reach 200 mm)



## DESCRIPTION

The set of three extremely narrow jaws is suitable for 3-jaw universal pullers. The trapezoidal contact surface of the claw ensures that even very tight and hard-to-reach gaps are accessed.

## APPLICATION AREA

As accessories for very tight and poorly accessible gaps.

## BENEFIT

- By using the freely movable, sliding jaws on the crossbar, eccentric components can also be pulled off.

## MASTER DATA

GTIN [EAN]	4021176321412
Country of origin	DE
Case material	Tool steel
Series	4-S
Net weight [kg]	1,56 kg
Package contents	1 set
Packaging Act	PAP 21
Global sales capability given	Yes (REACH, RoHS, POP, PROP65, TSCA)

## DETAIL IMAGE



# Extremely narrow jaws (set, reach 200 mm)

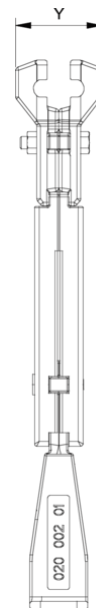
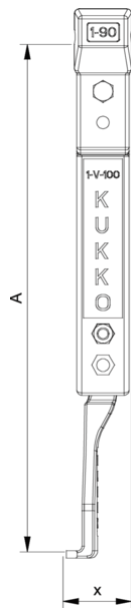

Abbreviation	Attribut	Wert
A	Clamping depth outside pull-off [mm]	200 mm
K	Hook root thickness at the tip (claw thickness K) [mm]	3 mm
J	Hook base width (claw width J) [mm]	24 mm
O	Hook base depth usable (claw depth usable O) [mm]	7 mm
H	Total hook root depth (total claw depth H) [mm]	12 mm
L	Total claw thickness (L+1mm) (claw distance to base surface) [mm]	3 mm
Z	Total length [mm]	227 mm

Abbreviation	Attribut	Wert
A	Clamping depth outside pull-off [mm]	200 mm
K	Hook root thickness at the tip (claw thickness K) [mm]	3 mm
J	Hook base width (claw width J) [mm]	24 mm
O	Hook base depth usable (claw depth usable O) [mm]	7 mm
H	Total hook root depth (total claw depth H) [mm]	12 mm
L	Total claw thickness (L+1mm) (claw distance to base surface) [mm]	3 mm
Z	Total length [mm]	227 mm

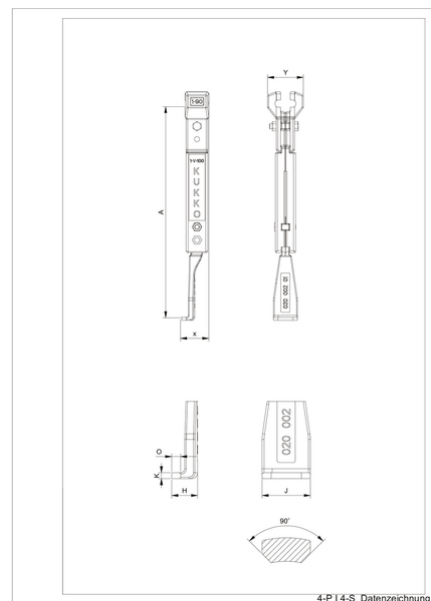
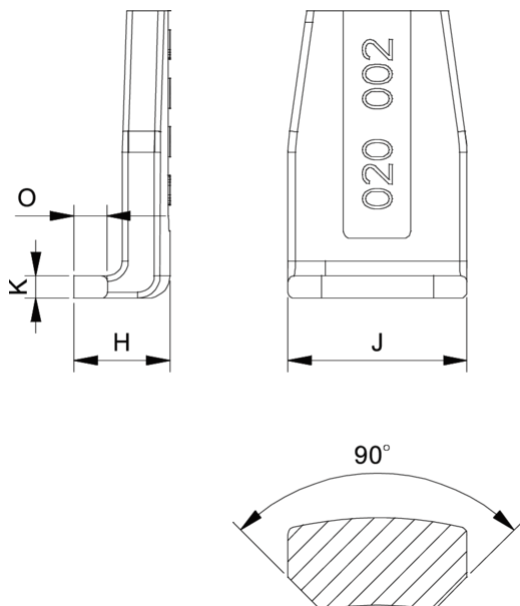

Abbreviation	Attribut	Wert
A	Clamping depth outside pull-off [mm]	200 mm
K	Hook root thickness at the tip (claw thickness K) [mm]	3 mm

Abbreviation	Attribut	Wert
A	Clamping depth outside pull-off [mm]	200 mm
K	Hook root thickness at the tip (claw thickness K) [mm]	3 mm

J	Hook base width (claw width J) [mm]	24 mm
O	Hook base depth usable (claw depth usable O) [mm]	7 mm
H	Total hook root depth (total claw depth H) [mm]	12 mm
L	Total claw thickness (L+1mm) (claw distance to base surface) [mm]	3 mm
Z	Total length [mm]	227 mm

J	Hook base width (claw width J) [mm]	24 mm
O	Hook base depth usable (claw depth usable O) [mm]	7 mm
H	Total hook root depth (total claw depth H) [mm]	12 mm
L	Total claw thickness (L+1mm) (claw distance to base surface) [mm]	3 mm
Z	Total length [mm]	227 mm