

3-501-S Narrow jaws (Set, reach 500 mm)



DESCRIPTION

The set of three narrow jaws is suitable for 3-jaw universal pullers. The narrow jaws ensure that even tight and hard-to-reach spaces are accessible.

APPLICATION AREA

As an accessory for tight and hard-to-reach spaces.

BENEFIT

- Through the freely movable jaws gliding on the crossbar, eccentric components can also be pulled off.

MASTER DATA

GTIN [EAN]	4021176729188
Country of origin	DE
Case material	Tool steel
Series	1-S
Net weight [kg]	1,1 kg
Package contents	1 set
Packaging Act	PAP 21
Global sales capability given	Yes (REACH, RoHS, POP, PROP65, TSCA)

DETAIL IMAGE



Narrow jaws (Set, reach 500 mm)

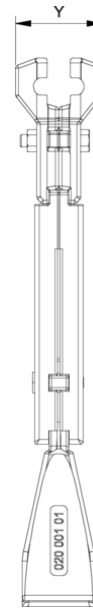
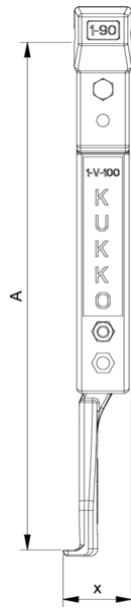

Abbreviation	Attribut	Wert
A	Clamping depth outside pull-off [mm]	500 mm
K	Hook root thickness at the tip (claw thickness K) [mm]	6,5 mm
J	Hook base width (claw width J) [mm]	35 mm
O	Hook base depth usable (claw depth usable O) [mm]	17 mm
H	Total hook root depth (total claw depth H) [mm]	52 mm
L	Total claw thickness (L+1mm) (claw distance to base surface) [mm]	6,5 mm
Z	Total length [mm]	540 mm

Abbreviation	Attribut	Wert
A	Clamping depth outside pull-off [mm]	500 mm
K	Hook root thickness at the tip (claw thickness K) [mm]	6,5 mm
J	Hook base width (claw width J) [mm]	35 mm
O	Hook base depth usable (claw depth usable O) [mm]	17 mm
H	Total hook root depth (total claw depth H) [mm]	52 mm
L	Total claw thickness (L+1mm) (claw distance to base surface) [mm]	6,5 mm
Z	Total length [mm]	540 mm

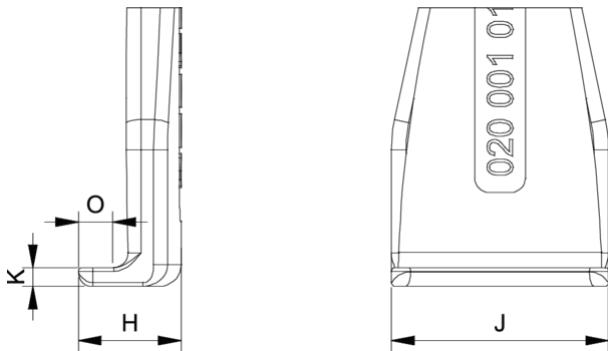

Abbreviation	Attribut	Wert
A	Clamping depth outside pull-off [mm]	500 mm
K	Hook root thickness at the tip (claw thickness K) [mm]	6,5 mm
J	Hook base width (claw width J) [mm]	35 mm
O	Hook base depth usable (claw depth usable O) [mm]	17 mm
H	Total hook root depth (total claw depth H) [mm]	52 mm
L	Total claw thickness (L+1mm) (claw distance to base surface) [mm]	6,5 mm
Z	Total length [mm]	540 mm

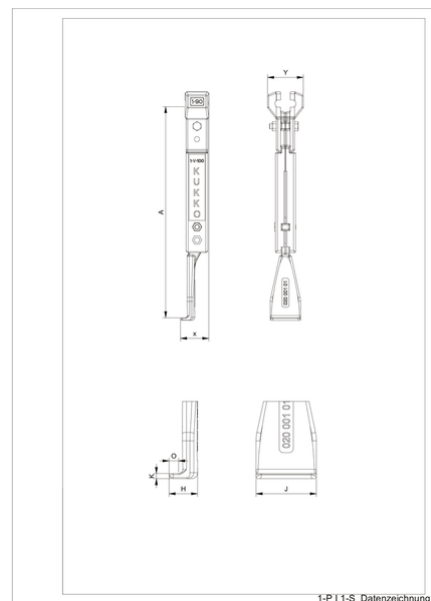

Abbreviation	Attribut	Wert
A	Clamping depth outside pull-off [mm]	500 mm
K	Hook root thickness at the tip (claw thickness K) [mm]	6,5 mm

J	Hook base width (claw width J) [mm]	35 mm
O	Hook base depth usable (claw depth usable O) [mm]	17 mm
H	Total hook root depth (total claw depth H) [mm]	52 mm
L	Total claw thickness (L+1mm) (claw distance to base surface) [mm]	6,5 mm
Z	Total length [mm]	540 mm