

2-301-P Narrow jaws (pair, reach 300 mm)



DESCRIPTION

The pair of two narrow jaws is suitable for 2-jaw universal pullers. The narrow jaws ensure that even tight and hard-to-reach spaces can be accessed.

APPLICATION AREA

As accessories for tight and hard-to-reach spaces.

BENEFIT

- Through the freely movable, gliding jaws on the crossbar, even eccentric components can be removed.

MASTER DATA

GTIN [EAN]	4021176703188
Country of origin	DE
Case material	Tool steel
Series	1-P
Net weight [kg]	2,535 kg
Package contents	1 few
Packaging Act	PAP 21
Global sales capability given	Yes (REACH, RoHS, POP, PROP65, TSCA)

DETAIL IMAGE



Narrow jaws (pair, reach 300 mm)

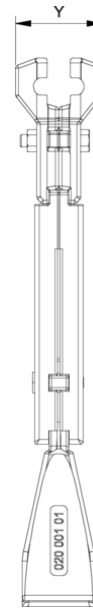
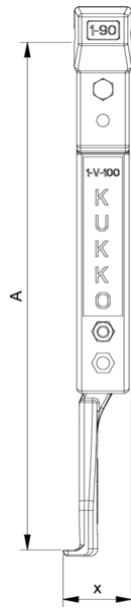

Abbreviation	Attribut	Wert
A	Clamping depth outside pull-off [mm]	300 mm
K	Hook root thickness at the tip (claw thickness K) [mm]	4 mm
J	Hook base width (claw width J) [mm]	32 mm
O	Hook base depth usable (claw depth usable O) [mm]	8 mm
H	Total hook root depth (total claw depth H) [mm]	19 mm
L	Total claw thickness (L+1mm) (claw distance to base surface) [mm]	4 mm
Z	Total length [mm]	336 mm

Abbreviation	Attribut	Wert
A	Clamping depth outside pull-off [mm]	300 mm
K	Hook root thickness at the tip (claw thickness K) [mm]	4 mm
J	Hook base width (claw width J) [mm]	32 mm
O	Hook base depth usable (claw depth usable O) [mm]	8 mm
H	Total hook root depth (total claw depth H) [mm]	19 mm
L	Total claw thickness (L+1mm) (claw distance to base surface) [mm]	4 mm
Z	Total length [mm]	336 mm

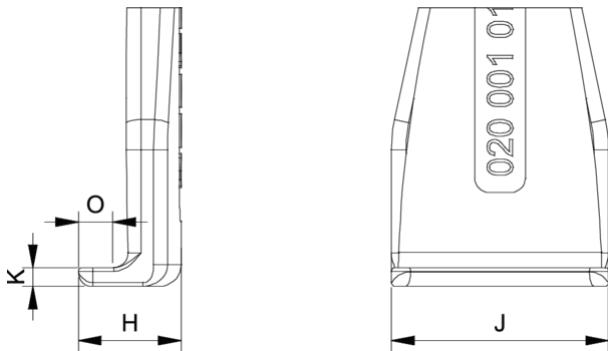

Abbreviation	Attribut	Wert
A	Clamping depth outside pull-off [mm]	300 mm
K	Hook root thickness at the tip (claw thickness K) [mm]	4 mm
J	Hook base width (claw width J) [mm]	32 mm
O	Hook base depth usable (claw depth usable O) [mm]	8 mm
H	Total hook root depth (total claw depth H) [mm]	19 mm
L	Total claw thickness (L+1mm) (claw distance to base surface) [mm]	4 mm
Z	Total length [mm]	336 mm

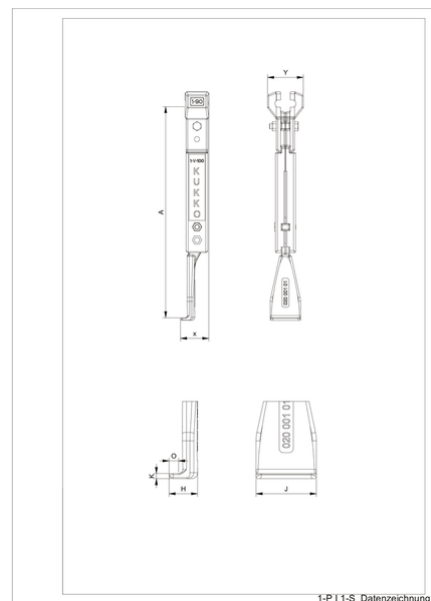

Abbreviation	Attribut	Wert
A	Clamping depth outside pull-off [mm]	300 mm
K	Hook root thickness at the tip (claw thickness K) [mm]	4 mm

J	Hook base width (claw width J) [mm]	32 mm
O	Hook base depth usable (claw depth usable O) [mm]	8 mm
H	Total hook root depth (total claw depth H) [mm]	19 mm
L	Total claw thickness (L+1mm) (claw distance to base surface) [mm]	4 mm
Z	Total length [mm]	336 mm