

3-400-P Standard jaws (pair, reach 400 mm)



DESCRIPTION

The pair of two standard jaws is suitable for 2-jaw universal pullers. The robust jaws guarantee a particularly secure removal of bearings, gears, and discs.

APPLICATION AREA

As a spare part for particularly safe extraction of bearings, gears, and discs.

BENEFIT

- The movable, sliding jaws on the crossbar allow for the extraction of eccentric components.

MASTER DATA

GTIN [EAN]	4021176003806
Country of origin	DE
Case material	Tool steel
Series	0-P
Net weight [kg]	5,33 kg
Package contents	1 few
Packaging Act	PAP 21
Global sales capability given	Yes (REACH, RoHS, POP, PROP65, TSCA)

DETAIL IMAGE



Standard jaws (pair, reach 400 mm)

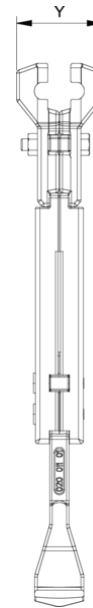
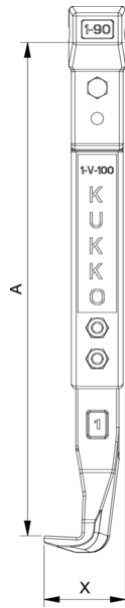

Abbreviation	Attribut	Wert
A	Clamping depth outside pull-off [mm]	400 mm
K	Hook root thickness at the tip (claw thickness K) [mm]	4 mm
J	Hook base width (claw width J) [mm]	35 mm
O	Hook base depth usable (claw depth usable O) [mm]	37 mm
H	Total hook root depth (total claw depth H) [mm]	67 mm
L	Total claw thickness (L+1mm) (claw distance to base surface) [mm]	20 mm
Z	Total length [mm]	450 mm

Abbreviation	Attribut	Wert
A	Clamping depth outside pull-off [mm]	400 mm
K	Hook root thickness at the tip (claw thickness K) [mm]	4 mm
J	Hook base width (claw width J) [mm]	35 mm
O	Hook base depth usable (claw depth usable O) [mm]	37 mm
H	Total hook root depth (total claw depth H) [mm]	67 mm
L	Total claw thickness (L+1mm) (claw distance to base surface) [mm]	20 mm
Z	Total length [mm]	450 mm

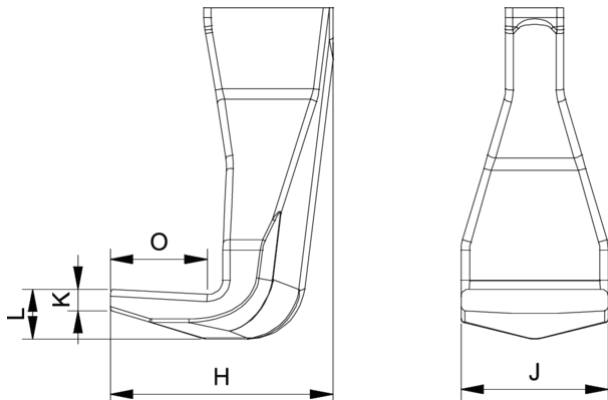

Abbreviation	Attribut	Wert
A	Clamping depth outside pull-off [mm]	400 mm
K	Hook root thickness at the tip (claw thickness K) [mm]	4 mm
J	Hook base width (claw width J) [mm]	35 mm
O	Hook base depth usable (claw depth usable O) [mm]	37 mm
H	Total hook root depth (total claw depth H) [mm]	67 mm
L	Total claw thickness (L+1mm) (claw distance to base surface) [mm]	20 mm
Z	Total length [mm]	450 mm

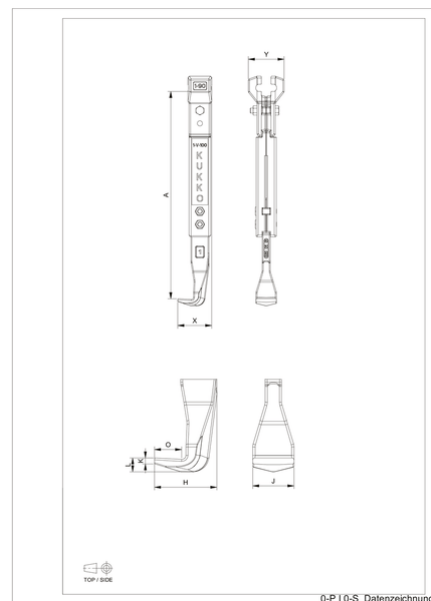

Abbreviation	Attribut	Wert
A	Clamping depth outside pull-off [mm]	400 mm
K	Hook root thickness at the tip (claw thickness K) [mm]	4 mm

J	Hook base width (claw width J) [mm]	35 mm
O	Hook base depth usable (claw depth usable O) [mm]	37 mm
H	Total hook root depth (total claw depth H) [mm]	67 mm
L	Total claw thickness (L+1mm) (claw distance to base surface) [mm]	20 mm
Z	Total length [mm]	450 mm