

18-314A Thread adapter (Pair) M14



DESCRIPTION

The thread adapters of series 18-A are used together with the pullers of series 18 for removing and pulling components with threads, such as dowel pins, keyways, or bolts, in crafts, industry, and workshops. The separation-puller process is capable of first gently separating those parts before they can be pulled out from the outside.

APPLICATION AREA

Together with the pullers of series 18 for pulling off and extracting components with threads, e.g. dowel pins, feather keys or bolts

BENEFIT

- The thread adapters allow for the careful and secure removal of parts with threaded holes.

MASTER DATA

GTIN [EAN]	4021176338601
Country of origin	DE
Case material	Tool steel
Series	18-A
Net weight [kg]	0,545 kg
Package contents	1 few
Packaging Act	PP 05
Global sales capability given	Yes (REACH, RoHS, POP, PROP65, TSCA)

SUITABLE FOR

- 18-3_puller

SPARE PARTS

- GE14-1815_spindle insert
- connecting nut

Thread adapter (Pair) M14

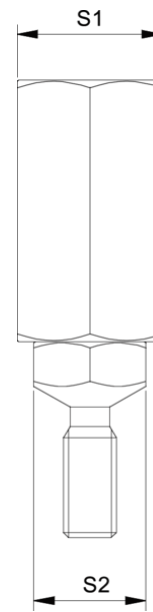
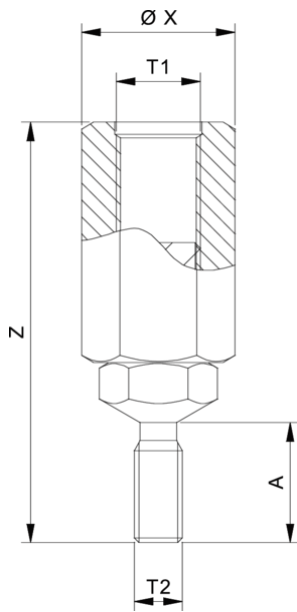

Abbreviation	Attribut	Wert
Z	Total length [mm]	94 mm
X	Outside diameter of the connecting nut [mm]	31 mm
S1	Width across flats connecting nut [mm]	27 mm
S2	Width across flats of thread insert [mm]	24 mm
A	Screw-in length of the thread adapter [mm]	29
T1	Mounting thread for tension bolt [nominal dimension]	M18x1,5
T2	Insert thread [nominal dimension]	M14

Abbreviation	Attribut	Wert
Z	Total length [mm]	94 mm
X	Outside diameter of the connecting nut [mm]	31 mm
S1	Width across flats connecting nut [mm]	27 mm
S2	Width across flats of thread insert [mm]	24 mm
A	Screw-in length of the thread adapter [mm]	29
T1	Mounting thread for tension bolt [nominal dimension]	M18x1,5
T2	Insert thread [nominal dimension]	M14

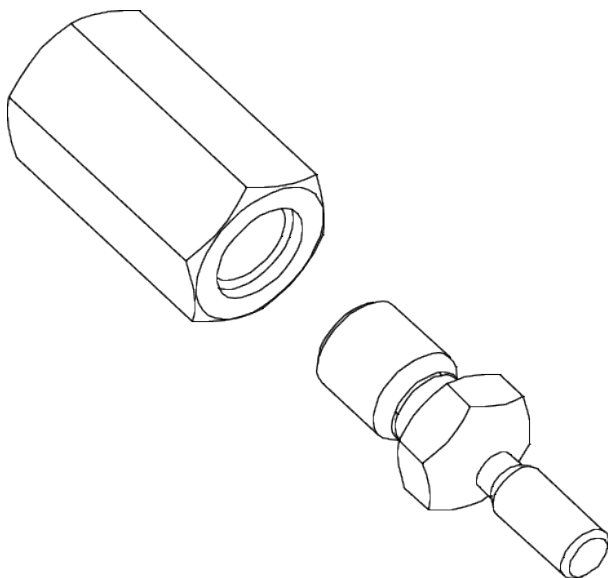

Abbreviation	Attribut	Wert
Z	Total length [mm]	94 mm
X	Outside diameter of the connecting nut [mm]	31 mm
S1	Width across flats connecting nut [mm]	27 mm
S2	Width across flats of thread insert [mm]	24 mm

A	Screw-in length of the thread adapter [mm]	29
T1	Mounting thread for tension bolt [nominal dimension]	M18x1,5
T2	Insert thread [nominal dimension]	M14