

# 18-210A Thread adapter (pair) M10



## DESCRIPTION

The thread adapters of series 18-A are used together with the pullers of series 18 for removing and pulling components with threads, such as dowel pins, keyways, or bolts, in crafts, industry, and workshops. The separation-puller process is capable of first gently separating those parts before they can be pulled out from the outside.

## APPLICATION AREA

Together with the pullers of series 18 for pulling off and extracting components with threads, e.g. dowel pins, feather keys or bolts

## BENEFIT

- The thread adapters allow for the careful and secure removal of parts with threaded holes.

## MASTER DATA

GTIN [EAN]	4021176338113
Country of origin	DE
Case material	Tool steel
Series	18-A
Net weight [kg]	0,27 kg
Package contents	1 few
Packaging Act	PP 05
Global sales capability given	Yes (REACH, RoHS, POP, PROP65, TSCA)

## SUITABLE FOR

- 18-2\_extracting device

## SPARE PARTS

- GE10-1415 spindle insert
- VM1415-1415\_connecting nut

# Thread adapter (pair) M10

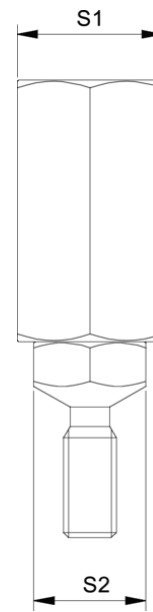
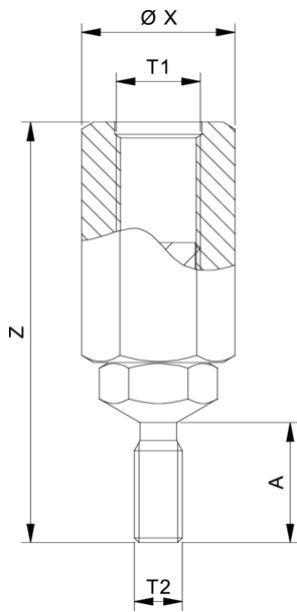

Abbreviation	Attribut	Wert
Z	Total length [mm]	75 mm
X	Outside diameter of the connecting nut [mm]	25 mm
S1	Width across flats connecting nut [mm]	22 mm
S2	Width across flats of thread insert [mm]	17 mm
A	Screw-in length of the thread adapter [mm]	25
T1	Mounting thread for tension bolt [nominal dimension]	M14x1,5
T2	Insert thread [nominal dimension]	M10

Abbreviation	Attribut	Wert
Z	Total length [mm]	75 mm
X	Outside diameter of the connecting nut [mm]	25 mm
S1	Width across flats connecting nut [mm]	22 mm
S2	Width across flats of thread insert [mm]	17 mm
A	Screw-in length of the thread adapter [mm]	25
T1	Mounting thread for tension bolt [nominal dimension]	M14x1,5
T2	Insert thread [nominal dimension]	M10

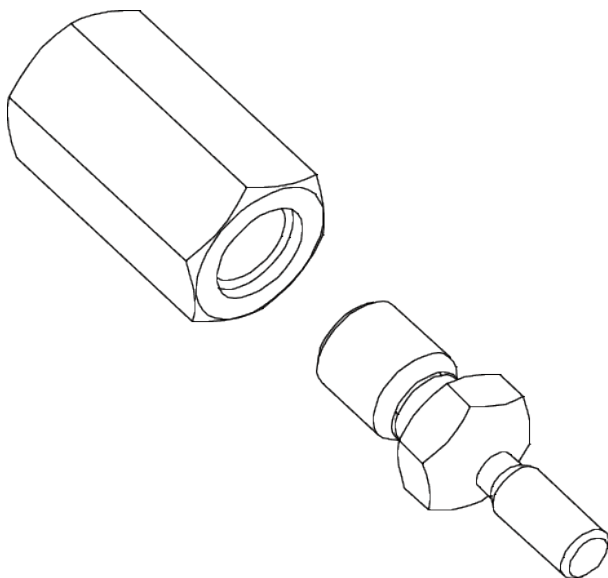

Abbreviation	Attribut	Wert
Z	Total length [mm]	75 mm
X	Outside diameter of the connecting nut [mm]	25 mm
S1	Width across flats connecting nut [mm]	22 mm
S2	Width across flats of thread insert [mm]	17 mm

A	Screw-in length of the thread adapter [mm]	25
T1	Mounting thread for tension bolt [nominal dimension]	M14x1,5
T2	Insert thread [nominal dimension]	M10